

# 2-way Control Valves type M2FR, Cast iron PN 16, DN 20 – 80 mm, 2 seats, Reverse acting

2.3.06-M

GB-1

## Characteristics

- Nominal pressure PN 16
- Regulating capability  $\frac{k_{vs}}{k_{vr}} > 25$
- Reverse acting (normally closed)
- For cooling systems or similar
- Adjustable seats

## Applications

Valves type M2FR are mainly intended for control of cooling systems.

The valves are used in conjunction with temperature or pressure differential regulators for controlling industrial processes or cooling systems.

As the reverse acting valves are held in closed position by means of a built-in spring, the max. differential pressure,  $\Delta p_L$ , against which a valve can close depends on the spring and when opening the valve, the actuator has to overcome the spring force.

The table below shows the max. allowable values of  $\Delta p_L$  as well as the max. allowable inlet pressures for opening the valves,  $p_{1max}$  for various actuator forces.

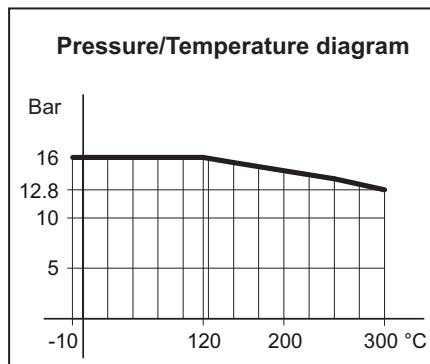

## Dimensioning

For sizing of control valves, please see "Quick Choice" leaflet no. 9.0.00.

## Design

The valve components - spindle, seats and cone - are made of stainless steel.

The valve body is made of cast iron EN-GJS-400-15 with flanges drilled according to EN 1092-2. The thread for the actuator connection is G1B ISO 228.

The valves are double-seated and designed for tight closure. The leakage rate is less than 0.5% of the full flow (according to VDI/VDE 2174).

## Quality assurance

All valves are manufactured under an ISO 9001 certification and are pressure and leakage tested before shipment.

## Function

Without an actuator being connected, the valve is held in closed position by means of a spring. With pressure on the spindle the valve opens.

In connection with our thermostats, the valves act as "cooling" valves, i.e. they open at rising temperatures.

The quadratic characteristic will not cease until the flow has dropped below 4% of the full flow.

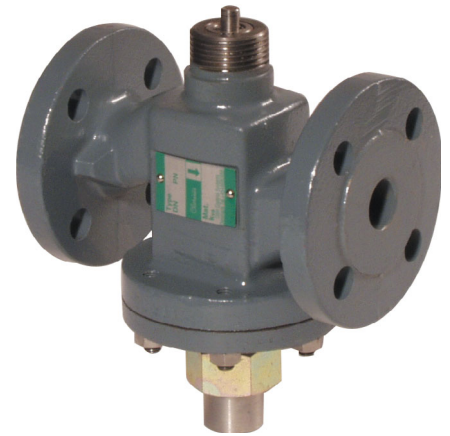

## Technical Data

Materials:

- Valve body	Cast iron EN-GJS-400-15
- Trim	Stainless steel
- Bolts, nuts	24 CrMo 4/A4
Nominal pressure	PN 16
Seating	Double seated
Flow characteristic	Quadratic
Regulating capability $\frac{k_{vs}}{k_{vr}} > 25$	
Function	Opening with pressure on spindle
Leakage rate	$\leq 0.5\%$ of $k_{vs}$
Temperature range	See pressure/temperature diagram
Mounting	See page 2
Flanges drilled according to	EN 1092-2
Counter flanges	DIN 2633/BS 4504
Colour	Grey

Subject to changes without notice.

Specifications								
Type	Flange connection DN in mm	Opening mm	$k_{vs}$ -value m <sup>3</sup> /h	Lifting height mm	Max. $\Delta p_L$ bar	Actuat. force N	Corresp. $p_{1max}$ bar	Weight kg
20 M2FR	20	20	5	6.5	8.3	200 400	9.4 16	5
25 M2FR	25	25	7.5	7	8	200 400	8.8 16	6.5
32 M2FR	32	32	12.5	8	7	400	16	9
40 M2FR	40	40	20	9	6.6	400	16	11
50 M2FR	50	50	30	10	5.8	400	15	16
65 M2FR	65	65	50	11	10	400 800	10 16	21
80 M2FR	80	80	80	13	6.7	400 800	10 16	38

# 2-way Control Valves type M2FR, Cast iron PN 16, DN 20 – 80 mm, 2 seats, Reverse acting

2.3.06-M

GB-2

## Definition of $k_{VS}$ -value

The  $k_{VS}$ -value is identical to the IEC flow coefficient  $k_V$  and defined as the water flow rate in  $m^3/h$  through the fully open valve by a constant differential pressure,  $\Delta p_V$ , of 1 bar.

## Mounting

Up to 170°C the valve can be installed vertically as well as horizontally. For media temperature above 170°C, a cooling unit of type KS has to be applied. It must then be installed with actuator/thermostats downwards, and according to the following instructions:

Valve Temperature	Cooling Unit	Suitable for
170°C - 250°C	KS-4	All actuators
250°C - 300°C	KS-5	Thermostats
250°C - 300°C	KS-6	Valve Motors

## Strainer

It is recommended to use a strainer in front of the control valve if the liquid contains suspended particles.

## Accessories

### Manual Adjusting Device

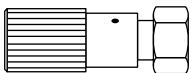

The device has a built-in stuffing box. For sealing and manual operation of valves when an actuator has not been fitted, e.g. during periods of construction.

### Cooling Unit KS-4

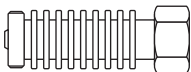

Cooling unit protecting the stuffing box of the motor/thermostat. To be applied at valve temperatures between 170°C and 250°C.

### Cooling Unit KS-5

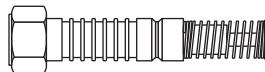

Cooling units with built-in bellows glands, replacing stuffing box of thermostat (KS-5) or valve motor (KS-6). Must be applied at valve temperatures above 250°C.

### Cooling Unit KS-6

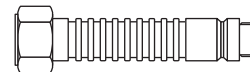

## Dimension sketch

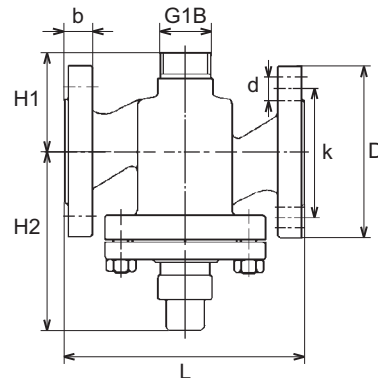

## Dimensions

Type	L mm	H1 mm	H2 mm	D (dia.) mm	b mm	k (dia.) mm	d mm dia. (number)
20 M2FR	150	63	112	105	16	75	14x(4)
25 M2FR	160	70	117	115	16	85	14x(4)
32 M2FR	180	75	151	140	18	100	19x(4)
40 M2FR	200	85	155	150	19	110	19x(4)
50 M2FR	230	95	169	165	19	125	19x(4)
65 M2FR	290	110	180	185	19	145	19x(4)
80 M2FR	310	120	180	200	19	160	19x(8)

Subject to changes without notice.